

3.2.2 Number of books and chapters in edited volumes/books published and papers published in national/ international conference proceedings per teacher during last five years (10)

Sl. No.	Name of the teacher	Title of the book/chapters published	Title of the paper	Title of the proceedings of the conference	Year of publication	ISBN/ISSN number of the proceeding	Whether at the time of publication Affiliating Institution Was same Yes/NO	Name of the publisher
1	Dr Sanjay A. Deokar	ICACDOT	Induction motor performance improvement using stator skewing	IEEE International Conference on Automatic Control and Dynamic Optimization Techniques (ICACDOT), 9 Sept. 2016 ,organized by International Institute of Information Technology, Pune.	2016		No	IEEE
2	Dr Sanjay A. Deokar	ICACDOT	The novel design of three phase autotransformer	IEEE International Conference Automatic Control and Dynamic Optimization Techniques (ICACDOT)”,9 Sept,2016,Organized by International Institute of Information Technology, Pune.	2016	pp.835-839.DOI: 10.1109/ICACDOT.2016.7877704	No	IEEE

3	Dr. Gawade Sharad	ICAM-ASD 2016	Effect of BHF on Springback-FEA approach, held at SGGGS, IE&T, Nanded.	International conference-Advanced and Agile Manufacturing and Agile Software Development (ICAM-ASD 2016)	2016		Yes	ICAM-ASD 2016
4	Dr Sanjay A. Deokar	ICDMAI	Harmonic mitigation in traction supply system using half bridge converter	IEEE International Conference on Data Management, Analytics and Innovation (ICDMAI), 24-26 Feb,2017	2017	DOI: 10.1109/ICDMAI.2017.8073503.pp. 161-165	No	IEEE
5	Dr Sanjay A. Deokar	ICONSTEM	Solar based fifteen level inverter to enhance power quality .	IEEE International Conference on Science Technology Engineering & Management (ICONSTEM), 23-24March, 2017, Chennai, India	2017	pp. 575-579,DOI: 10.1109/ICONSTEM.2017.8261388,	NO	IEEE
6	Dr Sanjay A. Deokar	I2CT	Advanced technique in micro grid protection for various fault by using numerical relay	IEEE International Conference on Convergence in Technology (I2CT), 7-9 Sept.2017,Mumbai , India.	2017	https://DOI: 10.1109/I2CT.2017.8226239. pp. 803-807	NO	IEEE

7	Dr Sanjay A. Deokar	ICCES	Switching power loss reduction in bidirectional AC/DC converter	IEEE International Conference on Communication and Electronics Systems (ICCES),19-20 Oct. 2017,Coimbatore, India.	2017	pp. 838-843.DOI: 10.1109/ICCES40938.2017	No	IEEE
8	Dr Sanjay A. Deokar	ICONSTEM	Simulation for cascade multilevel inverter to improve PQ using solar photovoltaic as input source	IEEE 3rd International Conference on Science, Technology and Management (ICONSTEM),23-24 March 2017,, Jeppiarr Engineering College,Chennai.	2017		No	IEEE
9	Dr Sanjay A. Deokar	Chapter 9, Springer Singapore, 12 December, 2017,	Optimal design configuration using HOMER”, Advances in Systems, Control and Automation	Lecture Notes in Electrical Engineering Series,442,	2017	https://doi.org/10.1007/978-981-10-4762-6 , pp.101-108, ISBN:978-981-10-4761-9.	No	Springer
10	S. M. Pondkule, D. D. Rupanwar	ICMAX 2017 Proceedings	A Review of Condition Monitoring to Detect the Defects in Rolling Element Bearing	ICMAX 2017	2017	ISBN : 978-93-24457- 41-5	No	ICMAX

11	Dr Sanjay A. Deokar	Designing and Simulation Tools of Renewable Energy Systems: Review Literature	Advanced Computing and Intelligent Engineering, Advances in Intelligent Systems and Computing,	Designing and Simulation Tools of Renewable Energy Systems: Review Literature, Vol 563 ,	2018	Online ISBN 978-981-10-6872-0. https://doi.org/10.1007/978-981-10-6872-0_29 , pp-315-324, Springer, Singapore, 09 February 2018	No	Springer
12	Dr Sanjay A. Deokar	GRID TIE	GRID TIE Solar Power Plant Data Acquisition System using Internet of Things	IEEE International Conference on Information , Communication, Engineering and Technology (ICICET)- 29-30 August, 2018	2018	DOI: 10.1109/ICICET.2018.8533857, Pune , India.	NO	IEEE
13	Dr Sanjay A. Deokar	Part of the Lecture Notes on Data Engineering and Communications Technologies book series	Protection of Microgrid with ideal Optimization Differential Algorithm	Springer International Conference on Computer Network Big Data and IoT (ICCBI-2019), on	2019	DOI: 10.1007/978-3-030-43192-1_79.	Yes	Springer
14	Dr Sanjay A. Deokar	Performance Improvement of I M. (LAMBERT Academic Publishing, Publication Date: April 27, 2020, Pages-52)	Performance Improvement of Induction Motor using Direct Torque Control	LAMBERT	2020	ISBN-13: 978-6202527019	Yes	LAMBERT

15	Bhosale A.C.	ICECA 2020	Electric Aircraft by Using AC/DCHybrid Electric Power Generation System”	ICECA 2020	2020	978-1-7281-6387-1	Yes	ICECA 2020
16	Dr Sanjay A. Deokar	Chapter 11, Springer Nature International Publication, Switzerland AG 2021,	Electric Power -Train Pre-fault Detection Using AI with IOT”, : Internet of vehicles and its applications in Autonomous Driving ,	Part of the book series of Unmanned System Technologies	2021	ISBN:978-3-030-46334-2. ,https://doi.org/10.1007/978-3-030-46335-9_11,pp.173-181,19 September ,2020,	Yes	Springer
17	Bhosale A.C.	I2CT2021	AC/DC Hybrid Electric Power Generation System for More Electric Aircraft by using Prototype	I2CT2021	2021	978-1-7281-8876-8	Yes	I2CT2021
18	Mayur M. Ghadage, Vishal B. Bhagwat, Shital R. Kadam, Shrinivas S. Shelage	International (Springer Book Chapter)	Modal Characteristics of Composite Sandwich Structure with Intermediate Layer of Viscoelastic Material	Advanced Technologies for Societal Applications- Techno-Societal 2020	2021	ISBN 978-3-030-69925-3	No	Springer
19	Shital R. Kadam, Mayur M. Ghadage, Prachi D. Kale	International (Springer Book Chapter)	Design and Weight Optimization of Critical Automobile Component- Steering Knuckle	Advanced Technologies for Societal Applications- Techno-Societal 2020	2021	ISBN 978-3-030-69925-3	No	Springer
20	Shilpa Sorate	ePGPEX-2022	IOT Based industrial plant saftety gas leakage	ePGPEX-2022	2022		Yes	Eppgex



Shri Someshwar Shikshan Prasarak Mandal's
Sharadchandra Pawar College of Engineering & Technology

Someshwarnagar, Tal – Baramati, Dist – Pune 412306

(Approved by AICTE New Delhi, Recognized by Govt. of Maharashtra &
 Affiliated to University of Pune, Id.no.PU/PN.Engg./445/2012)

Ph. (02112) 283185 * Fax : (02112) 283185

3.2.2 Number of books and chapters in edited volumes/books published and papers published in national/ International conference proceedings per teacher during last five years (10)

Sl. No.	Name of the teacher	Title of the book/chapters published	Title of the paper	Title of the proceedings of the conference	Year of publication	ISBN/ISSN number of the proceeding	Whether at the time of publication Affiliating Institution Was same Yes/NO	Name of the publisher
1	Dr Sanjay A. Deokar	ICACDOT	Induction motor performance Improvement using stator skewing	IEEE International Conference on Automatic Control and Dynamic Optimization Techniques (ICACDOT), 9 Sept. 2016, organized by International Institute of Information Technology, Pune.	2016		No	IEEE
2	Dr Sanjay A. Deokar	ICACDOT	The novel design of three phase autotransformer	IEEE International Conference Automatic Control and Dynamic Optimization Techniques (ICACDOT)", 9 Sept, 2016, Organized by International Institute of Information Technology, Pune.	2016	pp.835-839, DOI: 10.1109/ICACDOT.2016.7877704	No	IEEE
3	Dr. Gawade Sharad	ICAM-ASD 2016	Effect of BHF on Springback-FEA approach, held at SGGGS, IE&T, Nanded.	International conference-Advanced and Agile Manufacturing and Agile Software Development (ICAM-ASD 2016)	2016		Yes	ICAM-ASD 2016
4	Dr Sanjay A. Deokar	ICDMAI	Harmonic mitigation in traction supply system using half bridge converter	IEEE International Conference on Data Management, Analytics and Innovation (ICDMAI), 24-26 Feb, 2017	2017	DOI: 10.1109/ICDMAI.2017.8073503. pp. 161-165	No	IEEE
5	Dr Sanjay A. Deokar	ICONSTEM	Solar based fifteen level inverter to enhance power quality .	IEEE International Conference on Science Technology Engineering & Management (ICONSTEM), 23-24 March, 2017, Chennai, India	2017	pp. 575-579, DOI: 10.1109/ICONSTEM.2017.8261388,	NO	IEEE
6	Dr Sanjay A. Deokar	I2CT	Advanced technique in micro grid protection for various fault by using numerical relay	IEEE International Conference on Convergence In Technology (I2CT), 7-9 Sept. 2017, Mumbai, India.	2017	https://DOI: 10.1109/I2CT.2017.8226239_pp_803-807	NO	IEEE
7	Dr Sanjay A. Deokar	ICES	Switching power loss reduction in bidirectional AC/DC converter	IEEE International Conference on Communication and Electronics Systems (ICES), 19-20 Oct. 2017, Colmbatore, India.	2017	pp. 838-843, DOI: 10.1109/ICES40938.2017	No	IEEE



[Signature]
PRINCIPAL
 Sharadchandra Pawar College of Engineering & Technology
 Someshwarnagar, Tal. Baramati, Dist. Pune (Pin : 412 306),



Shri Someshwar Shikshan Prasarak Mandal's
Sharadchandra Pawar College of Engineering & Technology

Someshwarnagar, Tal – Baramati, Dist – Pune 412306
 (Approved by AICTE New Delhi, Recognized by Govt. of Maharashtra &
 Affiliated to University of Pune, Id.no.PU/PN.Engg./445/2012)
 Ph. (02112) 283185 * Fax : (02112) 283185

8	Dr Sanjay A. Deokar	ICONSTEM	Simulation for cascade multilevel Inverter to improve PQ using solar photovoltaic as input source	IEEE 3rd International Conference on Science, Technology and Management (ICONSTEM), 23-24 March 2017, Jeppia Engineering College, Chennai.	2017		No	IEEE
9	Dr Sanjay A. Deokar	Chapter 9, Springer Singapore, 12 December, 2017,	Optimal design configuration using HOMER", Advances in Systems, Control and Automation	Lecture Notes in Electrical Engineering Series, 442,	2017	https://doi.org/10.1007/978-981-10-4762-6_pp.101-108 , ISBN: 978-981-10-4761-9.	No	Springer
10	S. M. Pondkule, D. D. Rupanwar	ICMAX 2017 Proceedings	A Review of Condition Monitoring to Detect the Defects in Rolling Element Bearing	ICMAX 2017	2017	ISBN : 978-93-24457-41-5	No	ICMAX
11	Dr Sanjay A. Deokar	Designing and Simulation Tools of Renewable Energy Systems: Review Literature	Advanced Computing and Intelligent Engineering, Advances in Intelligent Systems and Computing,	Designing and Simulation Tools of Renewable Energy Systems: Review Literature, Vol 563,	2018	Online ISBN 978-981-10-6872-0. https://doi.org/10.1007/978-981-10-6872-0_29 , pp-315-324, Springer, Singapore, 09 February 2018	No	Springer
12	Dr Sanjay A. Deokar	GRID TIE	GRID TIE Solar Power Plant Data Acquisition System using Internet of Things	IEEE International Conference on Information, Communication, Engineering and Technology (ICICET)- 29-30 August, 2018	2018	DOI: 10.1109/ICICET.2018.8533857, Pune, India.	NO	IEEE
13	Dr Sanjay A. Deokar	Part of the Lecture Notes on Data Engineering and Communications Technologies book series	Protection of Microgrid with Ideal Optimization Differential Algorithm	Springer International Conference on Computer Network Big Data and IoT (ICCB-2019), on	2019	DOI: 10.1007/978-3-030-43192-1_79.	Yes	Springer
14	Dr Sanjay A. Deokar	Performance Improvement of I M. (LAMBERT Academic Publishing, Publication Date: April 27, 2020, Pages-52)	Performance Improvement of Induction Motor using Direct Torque Control	LAMBERT	2020	ISBN-13: 978-6202527019	Yes	LAMBERT
15	Bhosale A.C.	ICECA 2020	Electric Aircraft by Using AC/DC Hybrid Electric Power Generation System"	ICECA 2020	2020	978-1-7281-6387-1	Yes	ICECA 2020
16	Dr Sanjay A. Deokar	Chapter 11, Springer Nature International Publication, Switzerland AG 2021,	Electric Power - Train Pre-fault Detection Using AI with IOT"; Internet of vehicles and its applications in Autonomous Driving ,	Part of the book series of Unmanned System Technologies	2021	ISBN: 978-3-030-46334-2, https://doi.org/10.1007/978-3-030-46335-9_11 , pp.173-181, 19 September, 2020,	Yes	Springer
17	Bhosale A.C.	I2CT2021	AC/DC Hybrid Electric Power Generation System for More Electric Aircraft by using Prototype	I2CT2021	2021	978-1-7281-8876-8	Yes	I2CT2021
	M. G. Ghadge, Vishal B. Bhagwat, Shital R. Chalam, Shrihari S. Chakraborty	International (Springer Book Chapter)	Modal Characteristics of Composite Sandwich Structure with Intermediate Layer of Viscoelastic Material	Advanced Technologies for Societal Applications- Techno-Societal 2020	2021	ISBN 978-3-030-69925-3	No	Springer



PRINCIPAL
 Sharadchandra Pawar College of Engineering & Technology
 Someshwarnagar, Tal. Baramati, Dist. Pune (Pin : 412306)



Shri Someshwar Shikshan Prasarak Mandal's
Sharadchandra Pawar College of Engineering & Technology

Someshwarnagar, Tal – Baramati, Dist – Pune 412306
(Approved by AICTE New Delhi, Recognized by Govt. of Maharashtra &
Affiliated to University of Pune, Id.no.PU/PN.Engg./445/2012)
Ph. (02112) 283185 * Fax : (02112) 283185

19	Shital R. Kadam, Mayur M. Ghadage, Prachi D. Kale	International (Springer Book Chapter)	Design and Weight Optimization of Critical Automobile Component- Steering Knuckle	Advanced Technologies for Societal Applications- Techno-Societal 2020	2021	ISBN 978-3-030-69925-3	No	Springer
20	Shilpa Sorate	ePGPEX-2022	IOT Based Industrial plant safety gas leakage	ePGPEX-2022	2022		Yes	Eggpex

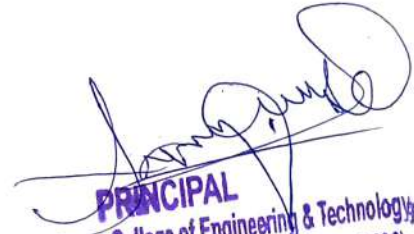

PRINCIPAL
Sharadchandra Pawar College of Engineering & Technology
Someshwarnagar, Tal. Baramati, Dist. Pune (Pin : 412 306)

Conferences > 2016 International Conference...

Induction motor performance improvement using stator skewing

Publisher: IEEE [Cite This](#) [PDF](#)

Pramod P. Marane; S.A. Deokar; Vishal L. Taihe All Authors

153 Full Text Views



Need Full-Text
 access to IEEE Xplore for your organization?
 CONTACT IEEE TO SUBSCRIBE >

Abstract

Document Sections

- I. Introduction
- II. Analysis of Induction Motor
- III. Mathematical Modeling
- IV. Design Implementation
- V. Specification

Show Full Outline ▾

Authors

Abstract:
 To improve the motor performance lot of work is going on by changing the skewing angle of the rotor. This paper presents induction motor with skews stator and rotor design with Matlab simulation and hardware implementation at the end. The performance of this motor is compared with the standard motor without skewing.

Published In: 2016 International Conference on Automatic Control and Dynamic Optimization Techniques (ICACDOT)

Date of Conference: 09-10 September 2016

INSPEC Accession Number: 16743991

Date Added to IEEE Xplore: 16 March 2017

DOI: 10.1109/ICACDOT.2016.7877713

ISSN Information

Publisher: IEEE

Conference Location: Pune, India



Sharadchandra Pawar
 Sharadchandra Pawar
 College of Engineering & Technology
 Someshwarnagar, Tal. Someshwar, Dist. Solapur
 Published: 2014

More Like This

A review of stator fault monitoring techniques of induction motor
 IEEE Transactions on Energy Conversion
 Published: 2005

Stator Fault Diagnostics in Squirrel Cage Three-Phase Induction Motor Drives Using the Instantaneous Active and Reactive Power Signature
 IEEE Transactions on Energy Conversion
 Published: 2014

IEEE.org | IEEE Xplore | IEEE SA | IEEE Spectrum | More Sites

IEEE Xplore [Browse](#) [My Settings](#) [Help](#) [Institutional Sign In](#) **IEEE**

Conferences > 2016 International Conference... **Abstracts**

The novel design of three phase autotransformer

Publisher: IEEE [Cite This](#) [PDF](#)

Vishal L. Tathe ; S A. Deokar [All Authors](#)

1 Paper 257 Full Text Views

Abstract **Abstract:**
The development of three phase auto transformer meet with some issues as by changing the conventional design we can reduce the costing as well as performance can be improved. This

Document Sections **More Like This** [Feedback](#)
Electromagnetic design

IEEE Xplore | IEEE SA | IEEE Spectrum | More Sites

IEEE Xplore [Browse](#) [My Settings](#) [Help](#) [Institutional Sign In](#) **IEEE**

Citation [Text Views](#)

Abstract **Abstract:**
The development of three phase auto transformer meet with some issues as by changing the conventional design we can reduce the costing as well as performance can be improved. This paper proposes a novel design of linear three phase auto transformer in which the design details and its performance is compared with conventional three phase toroidal core autotransformer. During study it is found that, there is a huge scope for modifications in autotransformers. At the end of paper its hardware design and performance analysis is conducted.

Document Sections **More Like This**
Electromagnetic design and thermal analysis of phase shift autotransformers
2016 International Symposium on Power Electronics, Electrical Drives, Automation and Motion (SPEEDAM)
Published: 2016
Analytical and FEM design of autotransformer with phase shifting capability by intermediate voltage variation
2016 XXII International Conference on Electrical Machines (ICEM)
Published: 2016

Published In: 2016 International Conference on Automatic Control and Dynamic Optimization Techniques (ICACDOT)

Date of Conference: 9-10 Sept. 2016 **INSPEC Accession Number:** 16744116

Date Added to IEEE Xplore: 16 March 2017 **DOI:** 10.1109/ICACDOT.2016.7877704

ISBN information: **Publisher:** IEEE

Conference Location: Pune, India

[Show Full Outline](#) [Show More](#) [Feedback](#)

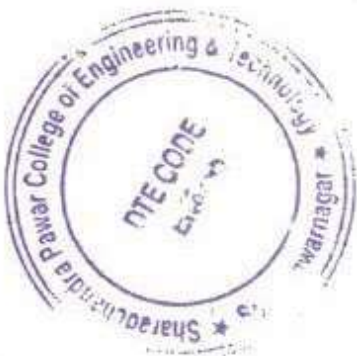

[Signature]
PRINCIPAL
Sharadchandra Pawar College of Engineering & Technology
Someshwarnagar, Tal. Baramati, Dist. ...
12 306

Harmonic mitigation in traction supply system by using half bridge converter

Publisher: IEEE [Cite This](#) [PDF](#)

Authors: Sujay Madane; S. A. Deokar [All Authors](#)

1 Paper
128 Full Text Views



Need Full-Text
 access to IEEE Xplore for your organization?
 CONTACT IEEE TO SUBSCRIBE >

Abstract

Document Sections

- I. Introduction
- II. Simulation Diagram with Output Waveforms
- III. Conclusion

Authors

Figures

References

Abstract:

The conventional electrified train locomotive load and large speed train load are having somewhat identical characteristics like enormous power, higher power factor, small harmonic factor and large negative sequence factor. As high unfavorable current introduced in to Supply system it have thoughtful results over the power supply system like additional losses due to motor vibration which causes increase in heat. Along with this it reduce the output of transformer and maloperation of relay system. Thus there might be vulnerability about the large accelerated train supply system and its power supply system also. In order to avoid all above consequences it will be significant to minimize negative sequence current and harmonic current. In this Paper we present the method for Power Conditioning of Traction system by using half bridge converter along with its result of reduced Harmonics using with compensation circuit. For maintaining the DC-link voltage absolute and complete with dynamic tracking of the reference current signals a double loop control planned for half bridge converter constant railway power conditioning. To regulate operation of HBRPC and to reduce the errors of capacitors voltages the balanced control method is used.

Published in: 2017 International Conference on Data Management, Analytics and Innovation (ICDMAI)

More Like This

Analysis of adverse effects on the public power grid brought by traction power-supply system
 2008 IEEE Canada Electric Power Conference
 Published: 2008

Advanced Coprime Traction Power Supply System Based on HBRPC to Single-Phase

[Signature]
PRINCIPAL
 Sharadchandra Pawar College of Engineering & Technology
 Someshwarnagar, Tal. Baramati, Dist. Solapur - 431 306



Conferences > 2017 Third International Conf...

Solar based fifteen level inverter to enhance power quality

Publisher: IEEE | Cite This | PDF

Krishna, D. Tiwari; Sanjay, A. Deokar | All Authors

1 Paper | 61 Full Text Views



Need Full-Text
 access to IEEE Xplore for your organization?
 CONTACT IEEE TO SUBSCRIBE >

Abstract

Document Sections

- I. Introduction
- II. Literature Review
- III. Research Methodology
- IV. Project Simulation Results
- V. Conclusion

Authors

Figures

Abstract:
 As there is growing concern about the best quality of power to be delivered, multilevel inverters had a great performance in raising the power quality by lessen the amount of switches thus access the level. This exert includes CMLI based analysis suitable for changing input from solar PV. This analysis endeavor to trace twain governing boundary and power circuitry to supply distinct amount of voltage levels by changing proper sequences. Therefore to achieve the requisite stage, the conservative methods need more switches and filter circuits whereas in our analysis only 10 switches are selected to have the prescribed levels. The approach is to minimise the rate of entire harmonics deformation by maximising the levels and hence improving the capacity of power. simulation for multistage inverter is presented according to IEEE standards and comparisons are made.

Published in: 2017 Third International Conference on Science Technology Engineering & Management (ICONSTEM)
 Date of Conference: 23-24 March 2017

INSPEC Accession Number: 17521285

More Like This

- Grid-connected PV inverter test system for solar photovoltaic power system certification
 2014 IEEE PES General Meeting | Conference & Exposition
 Published: 2014
- Reduction of Total Harmonic Distortion in Distribution System
 Penetration Utilizing D-STATCOM
 2014 IEEE PES General Meeting | Conference & Exposition
 Applications
 Published: 2014



PRINCIPAL
 Sharadchandra Pawar College of Engineering & Technology
 Someshwarnagar, Tal. Baramati, Dist. Solapur

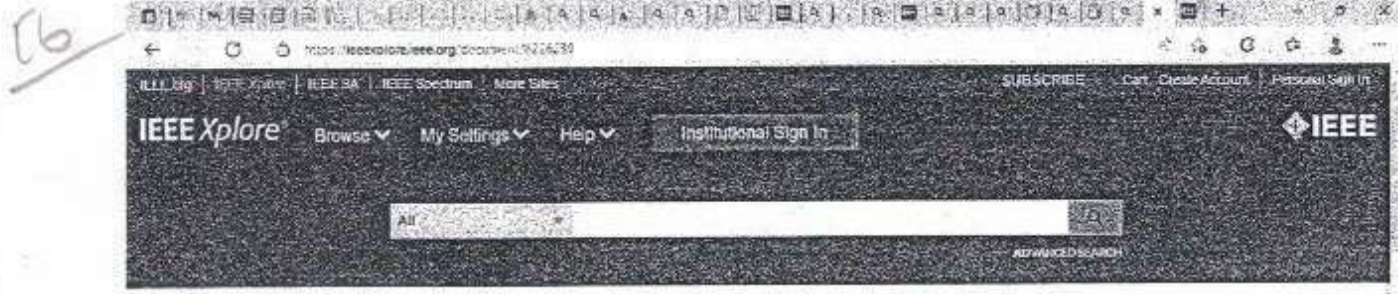

Conferences > 2017 2nd International Confer.

Advanced technique in micro grid protection for various fault by using numerical relay

Publisher: IEEE [Cite This](#) [PDF](#)

Pooja Khanolkar; S. A. Deokar; A. M. Dixit [All Authors](#)

2
Paper
Citations

251
Full
Text Views



Abstract

Abstract:

Microgrid is a part of Power System where energy is generated from renewable source and

[More Like This](#)

New concepts for distributed

[Feedback](#)

Abstract

Document Sections

- I. Introduction
- II. Fault Analysis in Microgrid
- III. Simulation of High Impedance Fault
- IV. Result and Conclusion

Authors:

Figures:

References:

Citations:

Keywords:

Metrics:

Abstract:

Microgrid is a part of Power System where energy is generated from renewable source and supplied to customer directly or indirectly. As traditional sources are going to vanish day by day demand of renewable sources goes on increasing. Trading renewable energy route can make India on the pathway to energy independent, low carbon emission, and build foundation for new generation with sustainable future. More research and implementation of microgrid will be conducted to improve micro grid technology. Among different aspects, most challenging task with renewable is protection. Because we cannot predict behavior of nature as it is uncontrollable for human kind. India is having plenty of renewable available as natural resources but challenge is to use it in optimized way. Hence protection of micro grid is key issues. This paper discuss technical challenges in protection of microgrid and suggested some solutions which help power system to use non-traditional sources in efficient way.

Published in: 2017 2nd International Conference for Convergence in Technology (I2CT)

Date of Conference: 7-9 April 2017	INSPEC Accession Number: 17449318	Show More
Date Added to IEEE Xplore: 21 December 2017	DOI: 10.1109/I2CT.2017.8229239	
► ISBN Information:	Publisher: IEEE	
	Conference Location: Mumbai, India	

More Like This

New concepts for distributed power generation and power quality for large scale integration of renewable energy sources

2006 European Conference on Power Electronics and Applications
Published: 2005

Optimal operational management methods of voltage control with a high feed of renewable energy sources

2018 IEEE International Energy Conference (ENERGYCON)
Published: 2018

[Feedback](#)



(Handwritten Signature)

PRINCIPAL
Sharadchandra Pawar College of Engineering & Technology
Someshwarnagar, Tal. Baramati, Dist. F. (112 306)

Conferences > 2017 2nd International Confer

Back to Results

Switching power loss reduction in bidirectional AC/DC converter

Publisher: IEEE

Cite This

PDF

Pranita B. Rajkuwar; Sanjay A. Deokar All Authors

97

Full

Text Views



Abstract

Abstract:

This paper proposes the simplified pulse width modulation (PWM) strategy in the bidirectional

More Like This

A Cost Effective Metho

Feedback

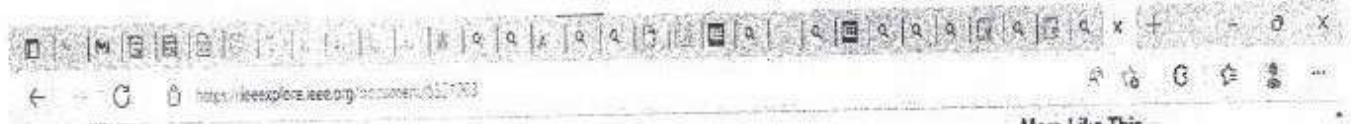

- Abstract
- Document Sections
 - I. Introduction
 - II. Single-Phase Bidirectional AC/DC Converter Model
 - III. Comparison of PWM Strategies
 - IV. Feedforward Control Scheme
 - V. Experimental Studies
- Show Full Outline

Abstract:
 This paper proposes the simplified pulse width modulation (PWM) strategy in the bidirectional ac/dc single-phase converter with the feed-forward control scheme. In this, the number of switching of the proposed simplified PWM strategy is reduced to one-fourth to that of the unipolar & bipolar PWM. The feed-forward control scheme is used to achieve better performance of the ac/dc converter in both the rectifier & inverter mode as compared with the conventional dual-loop control scheme. The simplified PWM strategy with feed-forward control scheme has higher efficiency than that of the unipolar PWM & bipolar PWM strategies. Also, the total harmonic distortion is less in this PWM strategy. The simulation & experiments are carried out to verify the validity of the proposed PWM strategy & control scheme.

Published in: 2017 2nd International Conference on Communication and Electronics Systems (ICES)
Date of Conference: 10-20 Oct. 2017 **INSPEC Accession Number:** 17650671
Date Added to IEEE Xplore: 22 March 2018 **DOI:** 10.1109/CESYS.2017.8321203

More Like This

- A Cost Effective Method of Reducing Total Harmonic Distortion (THD) in Single-Phase Boost Rectifier
 2007 7th International Conference on Power Electronics and Drive Systems
 Published: 2007
- The advantages of harmonic-distortion minimization over traditional harmonic-elimination techniques
 Proceedings of IEEE Power Electronics Specialist Conference - PESC '93
 Published: 1993

Show More

Authors

ISBN Information:

Publisher: IEEE

Conference Location: Coimbatore, India



Sanjay A. Deokar
PRINCIPAL
 Sharadchandra Pawar College of Engineering & Technology
 Baramati Tal. Baramati, Dist. P.

Feedback

69

Book Chapter

Optimal Design Configuration Using HOMER

Prashant Kumar and Sanjay Deokar

Abstract The aim of this chapter was to present an idea of using free sources of energy for designing stand-alone hybrid renewable energy system. This stand-alone hybrid system is used for powering the Electrical Engineering Department of AMGOI, located at latitude and longitude 16.8347 and 74.3148, respectively, of Peth Vadgaon Kolhapur, Maharashtra. The target of designing this system is to find the optimal net present cost (NPC), cost of energy, emissions, and monthly electricity production. The motive of this paper is to give optimal solution to the problems of energy crisis in the globe. In current scenario, the non-renewable sources are available in plenty amount to fulfill our increasing demand. Considering the above information, we have made an effort to analyze advantage of distributed generation. If we use only solar power or wind power, it can fluctuate and is not a reliable source of energy. The combination of solar and wind energy sources with diesel generator provides a reliable generation and a constant source of energy flow for the designed system. The main task of this research work is to analyze the possibility of solar-wind-diesel hybrid power system by maximizing the use of non-conventional generation system while minimizing the total system cost.

Keywords · Distributed generation · HOMER software · Optimal cost
Renewable energy

1 Introduction

In recent era, there is a great scope for advancement in power generation considering environment-friendly technology such as renewable energy technology which is technically viable and environment friendly. All over the world, effort is being made to study the feasibility of renewable energy incorporated within hybrid system which will prove to be the best alternative of diesel generator. In village, hybrid

P. Kumar (✉) · S. Deokar
Zeal College of Engineering and Research, Pune, India
e-mail: Prashant2685@gmail.com

© Springer Nature Singapore Pte Ltd. 2018
A. Konkani et al. (eds.), *Advances in Systems, Control and Automation*,
Lecture Notes in Electrical Engineering 442. https://doi.org/10.1007/978-981-10-4762-6_9

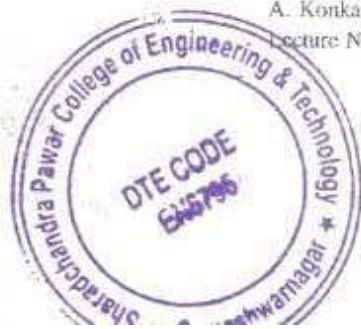

Sanjay Deokar
PRINCIPAL

Optimal Design Configuration Using HOMER

Prashant Kumar and Sanjay Deokar

Abstract The aim of this chapter was to present an idea of using free sources of energy for designing stand-alone hybrid renewable energy system. This stand-alone hybrid system is used for powering the Electrical Engineering Department of AMGOI, located at latitude and longitude 16.8347 and 74.3148, respectively, of Peth Vadgaon Kolhapur, Maharashtra. The target of designing this system is to find the optimal net present cost (NPC), cost of energy, emissions, and monthly electricity production. The motive of this paper is to give optimal solution to the problems of energy crisis in the globe. In current scenario, the non-renewable sources are available in plenty amount to fulfill our increasing demand. Considering the above information, we have made an effort to analyze advantage of distributed generation. If we use only solar power or wind power, it can fluctuate and is not a reliable source of energy. The combination of solar and wind energy sources with diesel generator provides a reliable generation and a constant source of energy flow for the designed system. The main task of this research work is to analyze the possibility of solar-wind-diesel hybrid power system by maximizing the use of non-conventional generation system while minimizing the total system cost.

Keywords Distributed generation · HOMER software · Optimal cost
Renewable energy

1 Introduction

In recent era, there is a great scope for advancement in power generation considering environment-friendly technology such as renewable energy technology which is technically viable and environment friendly. All over the world, effort is being made to study the feasibility of renewable energy incorporated within hybrid system which will prove to be the best alternative of diesel generator. In village, hybrid

P. Kumar (✉) · S. Deokar
Sharadchandra Pawar College of Engineering and Research, Pune, India
e-mail: Prashant2685@gmail.com

© Springer Nature Singapore Pte Ltd. 2018
A. Kulkarni et al. (eds.), *Advances in Systems, Control and Automation*,
Lecture Notes in Electrical Engineering 442, https://doi.org/10.1007/978-981-10-4762-6_9

PRINCIPAL

Sharadchandra Pawar College of Engineering & Technology
Someshwarnagar, Tal. Baramati, Dist. Solapur - 412 308



A Review of Condition Monitoring to Detect the Defects in Rolling Element Bearing

S. M. Pondkule^{*}, D. D. Rupanwar

Department of Mechanical Engineering, Vidya Pratishthan's Kamalnayan Bajaj Institute of Engineering and Technology, Baramati, Savitribai Phule Pune University, Pune, Maharashtra, India
^{*}sunilpondkule@gmail.com

Abstract

Health condition monitoring (CM) and diagnostics of rotating machinery requires the capability of properly characterizing the information content of sensor signals in order to detect and identify possible fault features. Bearing play a pivotal role in rotating machinery. Failure analysis of the bearing is mostly studied by running condition of the bearing and analysis is made with vibration signature tool (VST) for monitoring its condition. A minor investment toward predictive maintenance monitoring system can avoid untimely failures, machine downtime, maintenance cost etc. Experiments are carried out using the condition monitoring instrument like Accelerometer to measure vibration severity for different speed, load, material defects, and service life (SF). This would result in increased profits, safety, proper working of the machine for the intended duration of its life. This paper reviews the bearing degradation using LabVIEW.

Keywords: Rolling element bearings, Bearing defects, Speed, Vibration analysis, DAQ, LabVIEW.

1. INTRODUCTION

Rolling element bearings are essential parts of rotating machinery. A machine could be seriously harmful if faults occur in the bearings during service. Their movements and dynamic contribute to the overall vibration in a machine. Radially loaded rolling element bearings generate vibration even if they are geometrically perfect. This is because of the use of a finite number of rolling elements to carry the load [1]. The average life span of bearing is in minutes, but may vary significantly depending on the usage and hence is not enough to count working minutes. One of the crudest methods is to run the bearing until failure, and then struggle to repair to make them fit for further service. This procedure can be very expensive in terms of machine destruction and production loss and in addition can cause hazards to personnel. Condition monitoring (CM) is a method used for determining the working state and fitness of a machine for the purpose of detecting possible failures before they turn into functional failures. The CM process consists of uninterrupted data collection, interpretation,

and diagnosis and data analysis. CM is a part of predictive maintenance which is a widely used in maintenance philosophy also known as condition-based maintenance [2]. In industrial applications, these bearings are considered as critical mechanical components and a defect in such a bearing, unless detected in time, causes malfunction and may even lead to catastrophic failure of the machinery. Defects in bearings may arise during use or during the manufacturing process. Therefore detection of these defects is important for condition monitoring as well as quality inspection of bearings. Different methods are used for detection and diagnosis of bearing defects; they may be broadly classified as vibration and acoustic measurements, temperature measurements and wear debris analysis. Among these, vibration measurements are the most widely used several techniques have been applied to measure the vibration and acoustic responses from defective bearings; i.e. vibration measurements in time and frequency domains [3]. Thus for the last decades, condition based



PRINCIPAL
Sharadchandra Pawar College of Engineering & Technology
Sameshwarnagar, Tal. Baramati, Dist. ... 412 306)

11 B

SpringerLink

Book Chapter

Search Log in

Book cover

Progress in Advanced Computing and Intelligent Engineering pp.315-324

Designing and Simulation Tools of Renewable Energy Systems: Review Literature

Prashant Kumar & Sanjay Deokar

Conference paper | First Online: 09 February 2018

717 Accesses

Part of the Advances in Intelligent Systems and Computing book series (AISC, volume 563)

Abstract

Renewable energy hybrid system is one of the most promising, economical, and reliable options for electrifying rural areas. Hybrid energy systems are being utilized for minimizing usage of fossil fuels to reduce environmental effects. But analysis of hybrid system is quite complex; therefore, it requires software tools for design, analyze, and optimization of software. Motive of the paper is to introduce

PRINCIPAL

Sharadchandra Pawar College of Engineering & Technology
Someshwarnagar, Tal. Baramati, Dist. Solapur - 431 006





Progress in Advanced Computing and Intelligent Engineering pp 315–324 | [Cite as](#)

Designing and Simulation Tools of Renewable Energy Systems: Review Literature

Prashant Kumar & Sanjay Deokar

Conference paper | [First Online: 09 February 2018](#)

750 Accesses | 1 Citations

Part of the [Advances in Intelligent Systems and Computing](#) book series (AISC, volume 563)

Abstract

Renewable energy system is one of the most promising, economical, and reliable options for electrifying rural areas. Hybrid energy systems are being utilized for minimizing usage of fossil fuels to reduce environmental effects. But analysis of hybrid system is quite complex therefore, it requires software tools for design, analyze, and optimization of software. Motive of this paper is to introduce various major software tools required for design, analyze

Access via your institution

- Chapter EUR 29.95
Price includes VAT (India)
- DOI: 10.1007/978-981-10-6872-0_29
 - Chapter length: 10 pages
 - Instant PDF download
 - Readable on all devices
 - Own it forever
 - Exclusive offer for individuals only
 - Tax calculation will be finalised during checkout

	Buy Chapter	
> eBook		EUR 245.03
> Softcover		EUR 299.00

Shri Chandra Pawar College of Engineering & Technology
Someshwarnagar, Tal. Baramati, Dist. P.
412 306

Learn about institutional subscriptions

C12



Conferences > 2018 International Conference

GRID TIE Solar Power Plant Data Acquisition System using Internet of Things

Publisher: IEEE

Cite This

PDF

Anupama Patil ; Sanjay A. Deokar ; Abuzer Banderkar All Authors

3-280
Paper Full
Citations Text Views



Abstract

Abstract:

Use of solar PV cells to harness electricity has been more developed in recent years.

Back to Results

More Like This

Techno-economic feasibility

Feedback



- Document Sections
- I. Introduction
- II. Grid Tie Solar Pv System
- III. Internet Of Things(Iot).
- IV. Proposed Iot Based System Using Raspberry Pi To Monitor Solar Pv System
- V. Results
- Show Full Outline
- Authors

Abstract:

Use of solar PV cells to harness electricity has been more developed in recent years. Researchers are more focusing on to extract more power from available area. But more consideration should be given to the energy loss during power extraction. Because the energy loss means the wastage of available power. The one of the solutions to save energy loss is the-power plant monitoring. This paper describes the design of remote data acquisition system for solar plant using internet of things. The solar power plant monitoring will provide the real time data for net power, net/total energy and irradiance. This data will be helpful to take decision to schedule operation & maintenance activities & preventive maintenance.

Published in: 2018 International Conference on Information , Communication, Engineering and Technology (ICICET)

Date of Conference: 29-31 Aug, 2018

INSPEC Accession Number: 18264835

Date Added to IEEE Xplore: 15 November 2018

DOI: 10.1109/ICICET.2018.8533857

Publisher: IEEE

ISBN Information:

Conference Location: Pune, India

More Like This

Techno-economic feasibility analysis of a grid connected solar photovoltaic power system for a residential load

2014 First International Conference on Automation, Control, Energy and Systems (ACES)
Published: 2014

Experience on 10kW grid-connecting solar power station
2008 International Conference on Electrical Machines and Systems
Published: 2008

Show More

I. Introduction

Grid tie solar power plant data acquisition system using internet of things to improve the efficiency and its

Feedback



Sanjay Deokar
PRINCIPAL

Sharadchandra Pawar College of Engg
Someshwar Nagar, Tal. Baramati, Dis:

412 38

C13



SpringerLink

Search



International conference on Computer Networks, Big data and IoT

ICCBi 2019: *Proceeding of the International Conference on Computer Networks, Big Data and IoT (ICCBi - 2019)* pp 712–720 | [Cite as](#)

Protection of Microgrid with Ideal Optimization Differential Algorithm

P. M. Khanderi, S. A. Decker & A. M. Dixit

Conference paper | [First Online: 05 March 2020](#)

663 Accesses | [2 Citations](#)

Chapter EUR 24.95
Price excludes VAT (India)

- DOI: 10.1007/978-3-030-48193-1_79
- Chapter length: 9 pages
- Instant PDF download
- Readable on all devices
- Own it forever
- Exclusive offer for individuals only

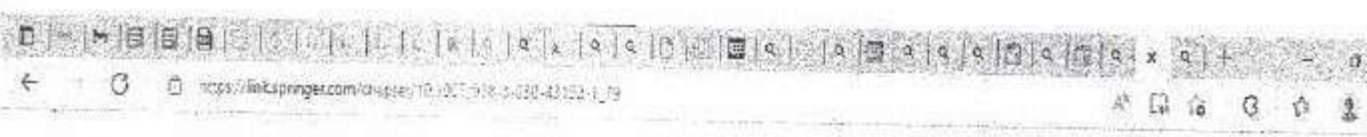

Abstract

This paper process DWT (Discrete wavelet transform)- differential algorithm for optimal relay coordination issue for the microgrid. This solution works for grid-connected as well as the disconnected mode of operation. Coordination among relays of the microgrid is a complex part to handle, as the insertion of DG causes a bidirectional flow of current. Propelled protection strategies including DWT analysis of short circuit current can give bright and savvy methods for protection. Previous work has been applied with the differential algorithm on grid-connected and islanded mode, but one major deficiency is an increase in operating time of primary and secondary relay which further decreases the reliability of Microgrid. The proposed system relies on DWT-differential Analysis based approach which removes all unwanted noise and bandwidth from fault signal and differential analysis helps to select the best pair of a relay. The issue is designed as a Non-linear programming problem to limit altogether working Relay time. The Scheme is tested with IEEE 9 bus system. The comparative analysis is carried out with two traditional methods; the result shows that it accomplishes a sensational decrease in working time in the primary and secondary (backup) relay.

Chapter EUR 24.95
Price excludes VAT (India)

- DOI: 10.1007/978-3-030-48193-1_79
- Chapter length: 9 pages
- Instant PDF download
- Readable on all devices
- Own it forever
- Exclusive offer for individuals only
- Tax calculation will be finalized during checkout

> eBook EUR 213.99

> Softcover Book EUR 248.99

- [Learn about institutional subscriptions](#)
- [Sections](#) [Figures](#) [References](#)
- [Abstract](#)
- [References](#)
- [Author information](#)



[Handwritten Signature]
PRINCIPAL
 Sharadchandra Pawar College of Engineering & Technology

C14 B

Book

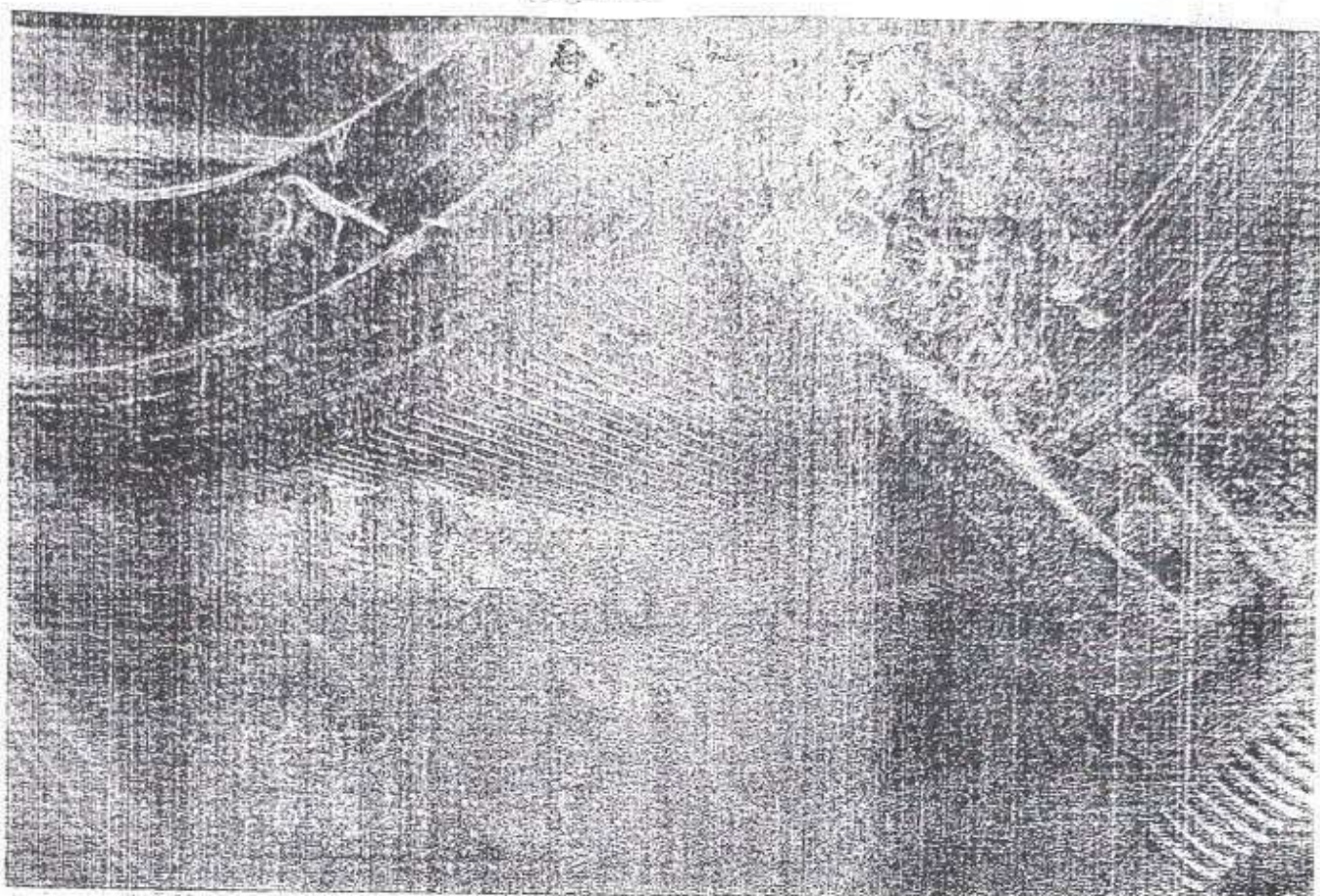

Suraj Karpe
Sanjay Deokar

Performance Improvement of Induction Motor using Direct Torque Control

Performance Improvement of IM



Sanjay Deokar
PRINCIPAL

Sharadchandra Pawar College of Engineering & Technology
Someshwarner, Tal. Baramati (17 306)

Sanjay Deokar



20

C16 B

SpringerLink

Book chapters

Search Q [Shopping Cart Icon] Log in

Book cover

Internet of Vehicles and its Applications in Autonomous Driving pp 173-181

Electric Power-Train Pre-fault Detection Using AI with IoT

Bapu Dada Kokare, Anil Kumar Gupta & Sanjay A. Deokar

Chapter | First Online: 19 September 2020

660 Accesses

Part of the Unmanned System Technologies book series (UST)

Abstract

This chapter describes application of AI tool to detect error for electric vehicle gearbox and design algorithm. Sequentially logged data demonstrate the condition monitoring approach and detects going to damage in the gear transmission that being done in advance. AI Auto correct drive experience great service system and assists to driver.

Sanjay Deokar
PRINCIPAL

Sharadchandra Pawar College of Engineering & Techn
Somnathnagar, Tal. Baramati, Dist - 412



Electric Aircraft by Using AC/DC Hybrid Electric Power Generation System

Ms. Bhosale Aishwarya C.

Electrical Engineering
G.H. Raison Institute of Engineering & Technology
Wagholi, Pune, India
aishwaryabhosale1313@gmail.com

Mrs. Sangita B. Patil

Electrical Engineering
G.H. Raison Institute of Engineering & Technology
Wagholi, Pune, India
Sangita.patil@raisoni.net

Abstract - The charge capacity of onboard airplanes is a developmental and irreversible change that will move quicker. The work on an airplane has built a pledge to reform vitality frameworks onboard airplanes, which will see pressure-driven and pneumatic force steadily being supplanted by power. The electrical force limit is expanding quickly, in an electric airplane, since the customary mechanical, pressure-driven and pneumatic essentialness structure are incompletely supplanted by the electrical force framework. As a result, the limit and multifaceted nature of airplane electric force frameworks will expand significantly, and further developed airplane EPSs should be created. The study concluded that the electric aircraft by using AC/DC combination electric power age framework. The study focuses on the generation of a combination of AC/DC, the electric force from a three-phase 230V AC source. Hence, generating +/- 270V DC distribution, 28V DC bus, and 115V AC distribution. The voltage level are maintained by using the PI controller system in the feedback way, so that by maintaining the PWM cycle, thus results in the voltage level maintained to its desired value.

Keywords— Electric Airplane, dispersed power invention, Generators, induction motors, power age control

1. INTRODUCTION

In the ongoing years, the investigation has centered on helping the dynamic increment in transportation jolt. Numerous causes have operated this exertion, remembering the impel for the decrease for contamination (regularly upheld by global understandings), the examination for better execution and the advancement of the innovation. The vehicle business previously saw the presentation of crossbreed autos and afterward completely stimulating car to facilitate can be observed today [1]. The expense of the coal and the manageability of the promote development be the essential navigate for this change. Concerning airplane production, the chance of the all-electric airplane (AEA) goes reverse in the directions of over 30 decades [10]. Moreover, the idea for cross-breed airplane impetus has been presented, giving a course build up the necessary innovations for electric drive [6-8]. These days, the

steady substitution of pressure-driven and aerial subdivision through their exciting partners taking place traditional airplane to be now a advertise actuality. The presence of the high-pressure bleed valve in the jet engine motivates and compromises the efficiency of the turbine. The hydraulic distribution systems are composed of pipes and pumps add up to a considerable amount of weight and can be prone to leaks. A malfunction of the hydraulic distribution system grounds the aircraft since corrosive fluids need to be removed and the system repaired.

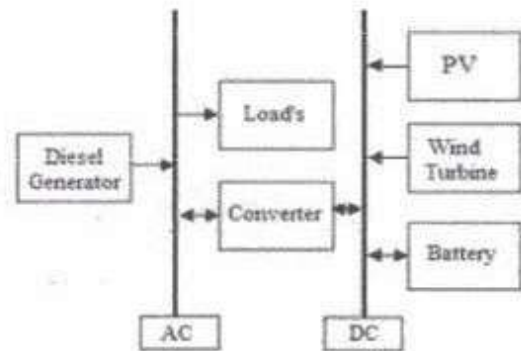

Fig.1. Hybrid power generation system.

The term "hybrid" is defined as having multiple energy sources. The most common implementation includes both gas and electricity. Such has been widely implemented in the auto industry where cars use both engines and batteries. Hybrid power supply system's consist of different energy sources to have a more secure supply of electrical loads with increased reliability and durability of the system. The hybrid systems take advantage of the strengths of the subsystems to overcome the weaknesses of the individual systems.

This structure extracts the progressively interesting airplane, however the impetus leftovers totally customary, during an additional exciting airplane just the methodology is charged. Here a traditional



Sangita B. Patil
PRINCIPAL
Sharadchandra Pawar College of Engineering & Technology
Wagholi, Pune, India

C18



Techno-Societal 2020

Organizing Committee

Dr. Anil Kakodkar
(Patron of Conference)

Chairman, Rajiv Gandhi Science and Technology Commission (RGSTC), Mumbai

Prof. Anil Sahastrabudhe
(Patron of Conference)

Chairman, All India Council for Technical Education (AICTE), Delhi

Dr. B.P. Ronge

(Chairman Organizing Committee),
Principal, SVERI's College of Engineering,
Pandharpur.

Dr. Prashant M. Pawar

(Coordinator Organizing Committee),
SVERI's College of Engineering, Pandharpur.

Dr. Santosh B. Salunkhe

(Co-Coordinator Organizing
Committee), Dean R&D-SVERI's College of
Engineering, Pandharpur.

Scientific Advisory Committee

- **Dr. Vijay Joshi**
(Consultant to Kypros group)
- **Dr. Shivaji Pawar**
(Deputy General Manager, NHA)
- **Dr. Boris Usmonov**
(Dy. Minister of the Higher edu. Uzbekistan)
- **Dr. Thomas Ochuku Mbuva**
(Chairman, Dept. of Mechanical & Manufacturing Engg., University of Nairobi)
- **Yelloji-Rao Mirajkar**
(Senior Technical Associate at Colgate Palmolive Company)
- **Dr. S. P. Arun**
(Associate Professor, Centre for Neuroscience, IISc, Bangalore)
- **Dr. V. K. Suri**
(Ex-Scientist, BARC, Mumbai)
- **Dr. Mrunalini (Leena) Pattarline**
(Program Director, M5 Biotechnology at Harrisburg University)
- **Mr. Ajit Patankar**
(Member, RGSTC, Mumbai)
- **Ms. Smita Mule** (BARC, Mumbai)
- **Dr. R. Balasubramaniam**
(Scientist, BARC, Mumbai)
- **Prof. K. Rajanna** (IISc Bangalore)
- **Prof. P. J. Guruprasad** (IIT Bombay)
- **Prof. P. K. Patowari**
(Professor, Department of Mechanical Engineering, NIT Silchar)
- **Dr. V. B. Patil**
(Director, School of Physics Sciences Professor, PAFSU, Solapur)
- **Prof. N. B. Pasalkar**
(BK, Director of Directorate of Technical Education (DTE) Govt. of Maharashtra)



3rd
International Conference

on

"Advanced Technologies for Societal Applications"

Certificate

This is to certify that MAYUR M. GHADAGE of Vidya Pratishthan's Kamalnayan Bajaj Institute of Engineering and Technology, Baramati has presented a Research Paper title Modal Characteristics of Composite Sandwich Structure with Intermediate Layer of Viscoelastic Material (Paper No. 54) in the International Conference on "Advanced Technologies for Societal Applications - Techno Societal 2020", held at SVERI's College of Engineering, Pandharpur (M.S.), India during 11-12 December, 2020.

Dr. P. M. Pawar
Coordinator
Organizing Committee

Dr. B. P. Ronge
Chairman
Organizing Committee



SHRI VITHAL EDUCATION & RESEARCH INSTITUTE'S
COLLEGE OF ENGINEERING, PANDHARPUR

www.sveri.ac.in, coe@sveri.ac.in



Sharadchandra Pawar
Principal
Sharadchandra Pawar College of Engineering & Technology
Someshwarnagar, Tal. Baramati, Dist. Solapur